

Transversals

Solve for x .

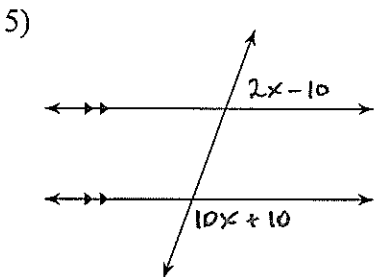
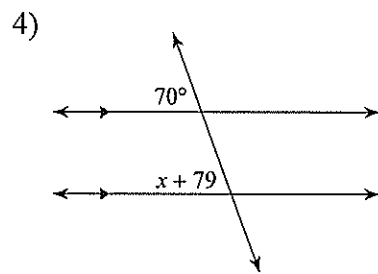
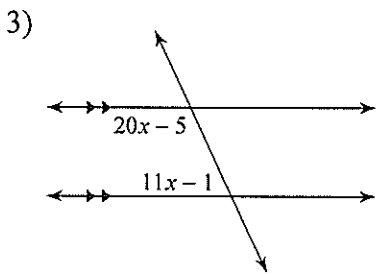
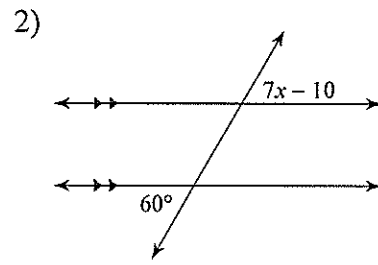
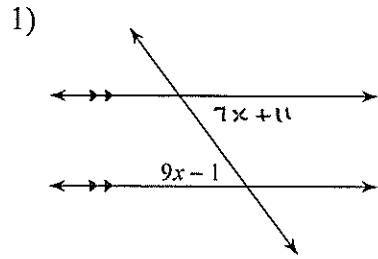

Find the measure of both angles.

6)

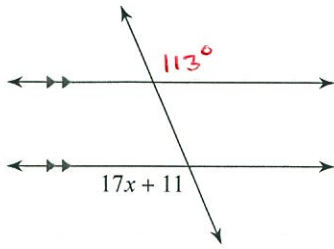

7)

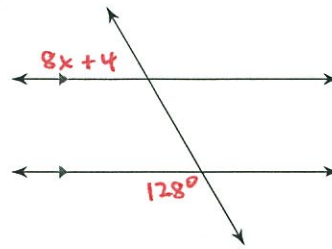

8)

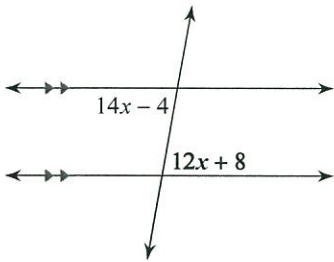

9)

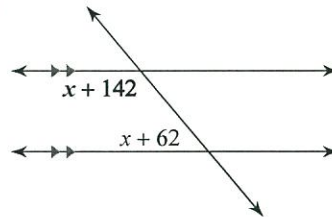

10)

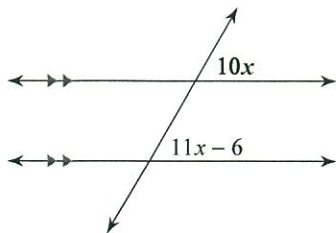

Solve for x .

11)

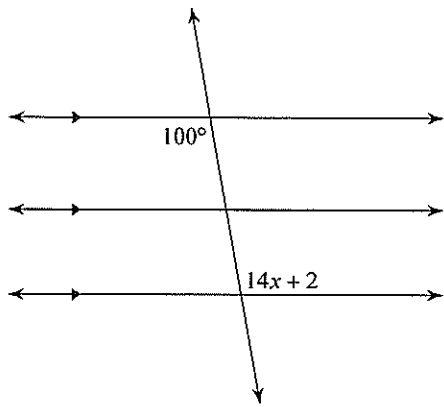

12)

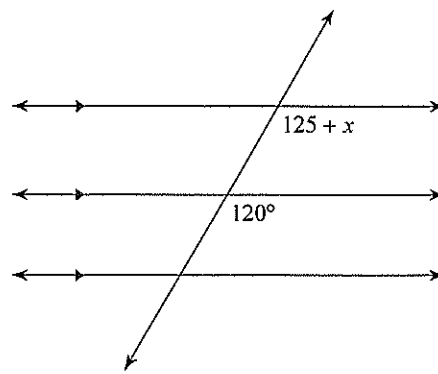

13)

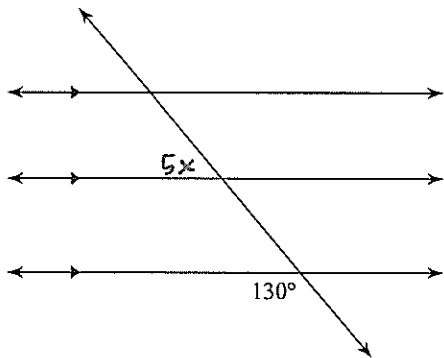

14)

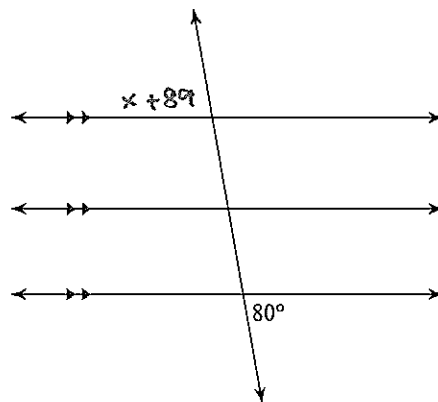

15)

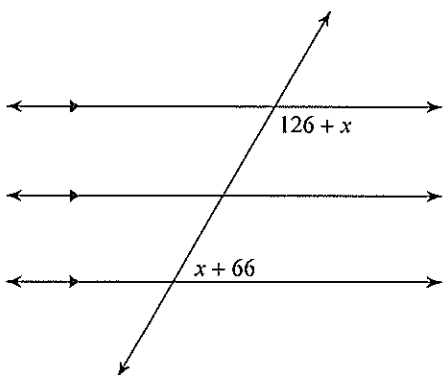

Find the measure of both angles.

16)

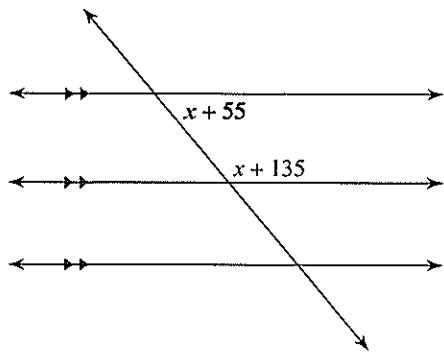

17)

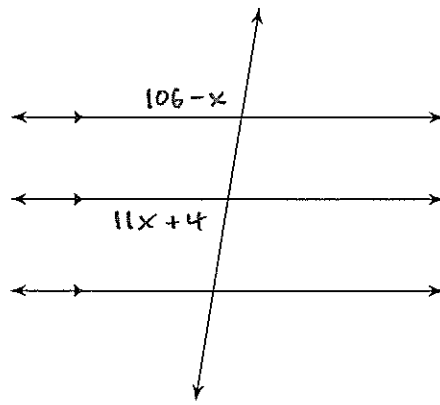

18)

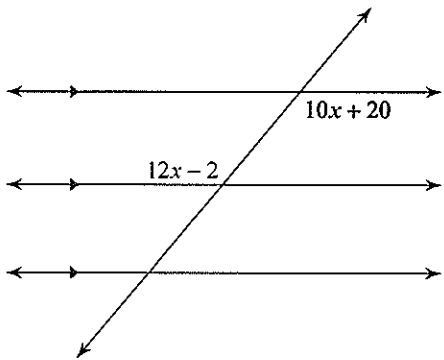

19)

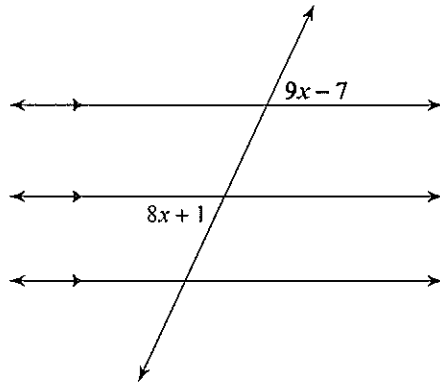

20)

